

# ChicoPlus cChicoPlus

High Speed Data Acquisition Card  
Flexible I/O Options  
PCI or CompactPCI/PXI

## Features

- Continuous Data Streams at 64 MB/sec
- Two OMNIBUS I/O Module Sites (one for cPCI)
- Multi-board Synchronization
- Direct Link to DSP Boards
- Low Cost

## Applications

- Data Loggers
- Arbitrary Waveform Generation
- High-Speed Data Acquisition
- Digital Data Streamer

## Hardware Options

- PCI or CompactPCI Bus
- FIFOCable pg 130
- 100 Pin MDR Breakout for PCI pg 131
- 50 Pin MDR Breakout for cPCI pg 131



### OMNIBUS Compatible

See page 73 for a complete list of OMNIBUS modules.

## Software Development Tools

- Armada pg 103

## Ordering Information

- ChicoPlus 80046-1
- ChicoPlus DevPack 90046-1
- CompactChicoPlus 80046-2
- CompactChicoPlus DevPack 90046-2



### DevPack Available

See page 91 for details

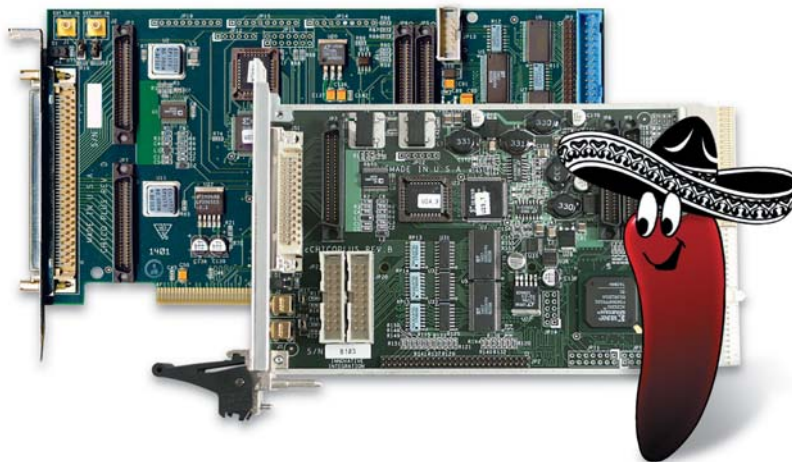

## Real-Time, Flexible Data Acquisition under Windows at rates to 64MBytes/sec

ChicoPlus is a flexible, high-performance data acquisition and playback card that allows you to integrate ultra-high speed, real-time acquisition and waveform generation on a desktop-PC or CompactPCI/PXI system at rates up to 64Mbytes/sec! It uses a revolutionary hardware architecture called Real-Time Data Streaming Engine (RTDSE) that uses modern gate-array and firmware to ensure gap-free, fast transfer rates between I/O channels and PC memory. Most importantly, this is performed with a minimum burden on the host CPU, unlike traditional data acquisition cards that cannot be "serviced" at high interrupt rates under Windows.

The astounding flexibility of ChicoPlus resides in the open OMNIBUS interface that can host two modules (one only for the CompactPCI card). The OMNIBUS modules are mezzanine cards that simply plug onto ChicoPlus and gives it the functionality that you need. Innovative Integration offers a vast choice of analog input and output channels that cover most any field of application in terms of channel count, resolution, sampling rate and trigger features. Plug in the OMNIBUS module of your choice, and you have just configured a ChicoPlus system that meets your project goals. From 16 simultaneous high-resolution channels for sonar, pro-audio or vibration analysis to transient capture at 40MHz, from arbitrary waveform generator to simultaneous 14-bit sampling at 10MHz, our OMNIBUS family of 15+ modules covers most of today's acquisition and playback needs. The OMNIBUS Module section of this catalog gives a detailed specification for each module card. Most of the modules can be mixed and matched on the same ChicoPlus board. And if your application requirements are not covered in this extensive set, you can develop your own OMNIBUS card like other customers have, because the OMNIBUS is an open specification 32-bit bus that is simple to interface with and well documented.

ChicoPlus supports simultaneous input and output streams operating at different rates and composed of multi-channel analog and digital samples. The software supports almost any acquisition/playback schemes or trigger modes with the highest bandwidth: snap capture, continuous streaming, external triggering, re-triggered framed acquisition.

With far more capabilities than canned data acquisition software packages, the Armada tool suite is a collection of visual software components that are easily configured and "assembled" to collect data, analyze it, process it, record it, display it. The functions provided give you full control over the triggering and data collection/playback process. These include hardware configuration and initialization, timebase and trigger setup, runtime graphs, disk logging, "on-the-fly" processing by the host using Intel DSP libraries and much more, all under a true native C++ environment that guarantees the highest runtime performance on a truly open platform.

OMNIBUS Module	Analog In			Analog Out		
	No. of Channels	Resolution (bits)	Sample Rate	No. of Channels	Resolution (bits)	Sample Rate
	A4D1	4	14	0-10 MHz	1	14
A4D4	4	16	0-200 kHz	4	16	0-200 kHz
A16D2	16*	16	0-200 kHz	2	16	0-2 MHz
AD16	16	16	5-195 kHz			
AD40	2	12	0-40 MHz			
AIX	4	16	0-2.5 MHz			
AIX20	4	12	0-20 MHz			
DAC40				4	14	0-40 MHz
RF	2	12	0-65 MHz	2	12	0-65 MHz
SD	4	24	2-96 kHz	4	24	30-96 kHz
SD16	16	18	24-48 kHz	16	18	32-48 kHz
Servo16	16	16	1-100 kHz	16	16	0-100 kHz

\*16:1 muxed

	Hardware	Software
<b>Flexibility</b>	Choice of mezzanine for I/O External trigger and clock Bidirectional streaming System level integration with: - FIFOPort - Multicard sync - PXI support	Different acquisition modes: - Continuous (streaming) - Snap (Finite capture) - Trigger and retrigger Truly Open environment Easy integration with other tasks and custom processing algorithm
<b>Performance</b>	Real-time Acquisition (HW clock) 64MBytes/sec to PC memory FIFO buffering in hardware Low interrupt rate to host SCSI disk logging	Contiguous physical memory Buffer sizing for low interrupt rate Block mode streaming with substream processing Intel NSP libraries for signal processing (MMX,SIMD optimized) Native C++ code for fastest runtime execution
<b>Ease of Use</b>	Pick your own I/O mezzanine Plug-n-Play installation Easy multicard setup & sync.	Turnkey applications Visual components and OpenWire connections Little or no code to write Drag-n-drop prewritten software components for: - hardware config - time trigger config - graphing - disk logging - DSP libraries

**ChicoPlus combined with Armada provides Flexibility, Performance and Ease of Use.**

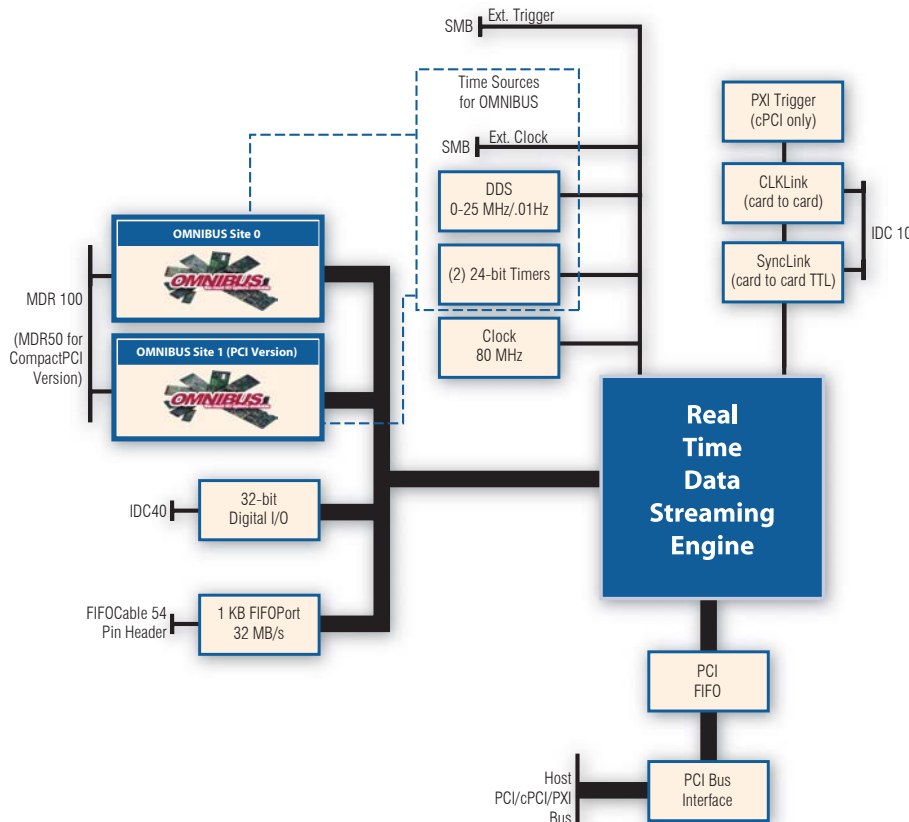

ChicoPlus is a common platform baseboard providing the data moving functions and numerous generic peripherals while the OMNIBUS mezzanine cards of your choice will provide the type of analog channels specific to YOUR application.

Every ChicoPlus baseboard comes with a set of standard peripherals:

- 32 bits of digital I/O configurable as input or output in bytes
- FIFOPort providing an external data port to/from external hardware
- Direct Digital Synthesizer for ultra-high resolution timebase 0-25MHz
- Two timers/counters
- External clock input and external trigger input
- SyncLink/ClockLink interface for multi-card synchronization
- Fastest 32-bit PCI interface

CompactChicoPlus, in addition, features full support of the PXI extension for CompactPCI/PXI platforms, to allow integrators to easily share timebase and trigger signals with other PXI boards on the bus.

### System Level Integration

System level integration of ChicoPlus is also greatly facilitated. The FIFOPort provides a dedicated 16-bit high-speed bi-directional communication link to/from external hardware with buffered input FIFO. For example ChicoPlus has been used to capture industrial digital camera data and stream it to PC memory, and also as front-end analog acquisition for DSP systems. The SyncLink/ClockLink allows to exchange four timing signals or event triggers among multiple ChicoPlus cards or other hardware, with a simple ribbon connection and software selection. CompactChicoPlus is a PXI-compliant 3U card and supports sharing of system reference clock, trigger bus and start trigger bus either as master or slave. Routing matrix and source/salve selection is easily defined in software.

## Hardware Driven Performance ... All the way... From analog converters to PC memory ... And beyond.

The very essential goal that Innovative Integration had set for the development of ChicoPlus was pure performance, i.e. to obtain the highest data transfer rates and data processing rates attainable on a desktop or industrial PC. In our company history, we had designed several data acquisition boards using DSP chips as the real-time data movement engine: the technical result was very satisfying for the times, but it was costly and any reconfiguration required DSP tools and expertise. Advancement in FPGA chips and logic design tools, as well as in "Wintel" systems performance, have allowed us to conceive a better system yet, using a state-of-the-art hardware architecture and well crafted software tools that together deliver the best combination in speed, flexibility and ease-of-use. Many data acquisition cards on the market can take control of the bus and move data to PC memory. But ChicoPlus goes further by combining clock-driven onboard data streaming with dynamic data buffering on host system and in contiguous physical memory: the benefit of this approach is a minimum burden on the host CPU which is absolutely essential to achieve this blazingly fast streaming rate of 64MBytes/sec.

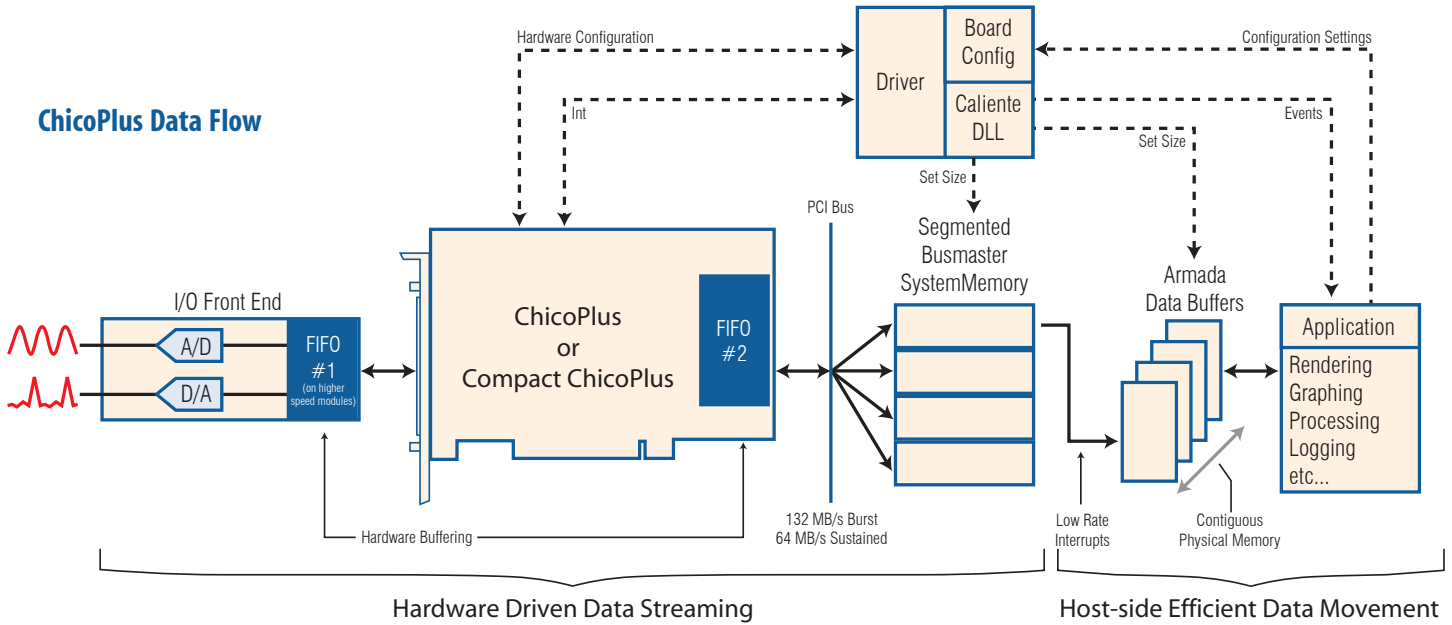

The hardware events driving the data movement can be timers, external triggers, system triggers from other ChicoPlus cards or PC events. These are all software selectable during configuration and may be dynamically reconfigured at runtime. Data streams are assembled from any I/O devices of ChicoPlus and installed OMNIBUS modules, and the system supports simultaneous input and output streams operating at different rates. For example, ChicoPlus can send an input stream to PC memory composed of several A/D channel readings, a timestamp and a digital input byte while retrieving data from file to be played on several D/A channels and digital output, all of this at the finest clock resolution.

The hardware provides FIFO (First In - First Out) buffering at different stages to tolerate CPU load variations typical of a PC and ensure gap-free streaming. On the host system, pool buffer sizes are calculated automatically at start-up to yield an interrupt rate on the order of 10 to 50Hz that can easily be serviced under Windows in typical conditions. Furthermore memory blocks are pooled and allocated in a contiguous physical memory region, an important task that will also contribute in minimizing CPU load at run time. The entire data flow from the analog converter front end, all the way to within application memory, has been engineered to deliver a gap-free streaming at the highest ultimate speed.

Finally, asynchronous, mailbox type slave accesses to other peripherals may be interleaved within this high-bandwidth data stream, in order to provide an additional slow rate data path so useful in control applications.

This can be used to change some digital input on a user-command, read another analog channel when the software detects a certain condition in the main data stream, or simply update a DAC channel at regular, non-critical, time intervals. These events are asynchronous to the streaming sequencer timing but are handled very well by the hardware as a low-rate interrupt. Complex control schemes can be interlaced within a high-rate, real-time data streaming, offering the best possible combination of performance and flexibility.

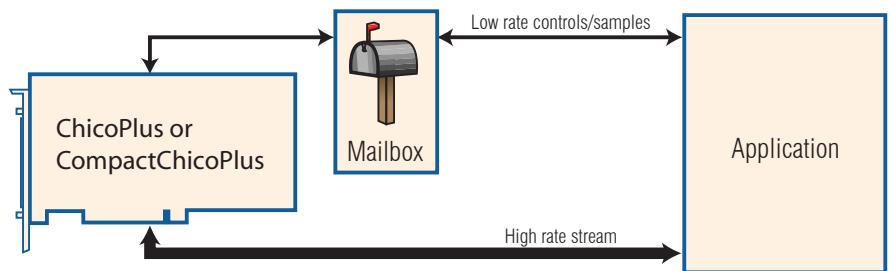

**Host side software ARMADA keeps up with ChicoPlus Blazing Speed!**

Once data has been bus-mastered into host memory, the Armada software allows you to manipulate it and move it very efficiently for your rendering, graphing, processing and logging functions. Armada provides the most efficient and flexible runtime software for all these functions, with no code for you to write!

Armada supports numerous acquisition modes to serve most any field of application.

**STREAMING MODE (Block Mode or Channelized Mode)**

Data flows continuously from hardware to the application and vice-versa. The application may perform continuous analysis, display and other operations. Maximum achievable data rates will depend on the amount of processing required. A typical multi-channel graphing in user-format will sustain aggregate rates in excess of 12 Msamples/second. For data logging to disk, the rate for Windows files is limited to about 2MBytes/sec while a dedicated disk with SCSI controller will exceed 20MBytes/sec gap-free (see our Andalé package). Example: vibration monitoring/analysis, sonar capture/analysis, audio/video acquisition.

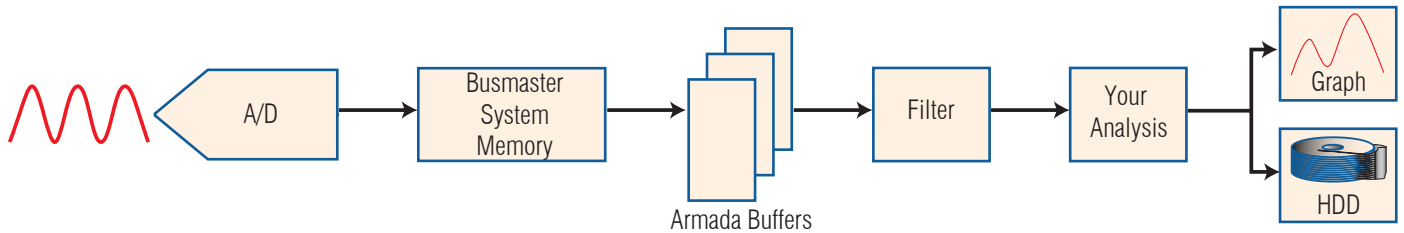

**TRANSIENT CAPTURE ( Snap Mode)**

Data is captured from the hardware to the host memory at rates up to 64MBytes/sec, gap-free. This is different than the hardware capture to FIFO buffers that is available on certain OMNIBUS modules like the AD40 or A4D1. This mode still delivers a continuous data transfer at high rates over the PCI bus but is limited only by the physical RAM available on the PC, and thus can reach close to 4 GBytes. Data collection is then halted and the captured data can be analyzed, processed, logged to disk at a lower rate. Example: wireless IF burst capture, spectroscopy, anything requiring maximum rate.

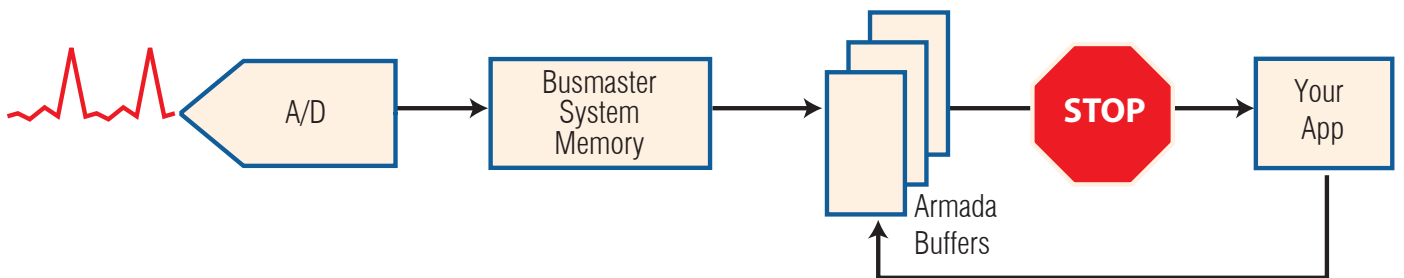

**STIMULUS/RESPONSE MODE (Block Mode or Channelized Mode)**

This is a bi-directional streaming mode. The application may continuously stream data or burst data as a stimulus to an external system and at the same time record and analyze the response. Because the streaming in both direction is driven with hardware events (essentially a clock), there is perfect input/output channel alignment. Pre-capture stimulus is also possible. Example: semiconductor testing, SONAR, open-loop control, scanner.

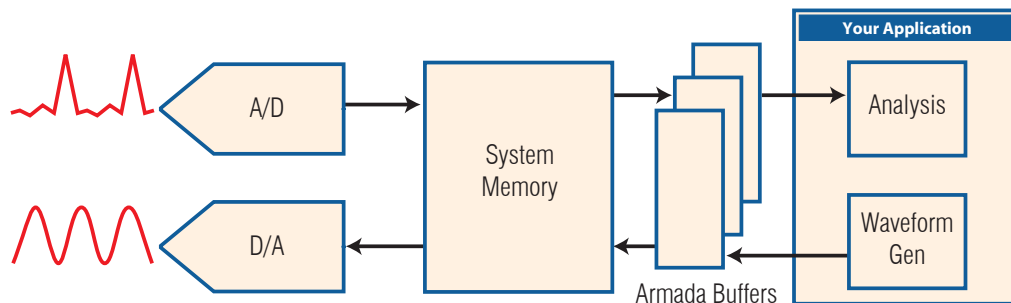

## RE-TRIGGERED FRAMED CAPTURE

This mode is actually a subset of the previous Streaming Mode. The ChicoPlus sequencer is controlled by either a train of external trigger signals (at any irregular spacing) or by the onboard timer/counter. The acquisition is therefore gated ON and OFF, forming a succession of fixed length frames. The concatenated data of successive frames flow continuously over the PCI bus to PC memory. This mode is useful to selectively capture signals of interest only for analysis. It reduces system load and allows the user to synchronize capture with external triggers. Example: cycling events like spark plug triggered combustion study, photonics, voice activated recording.

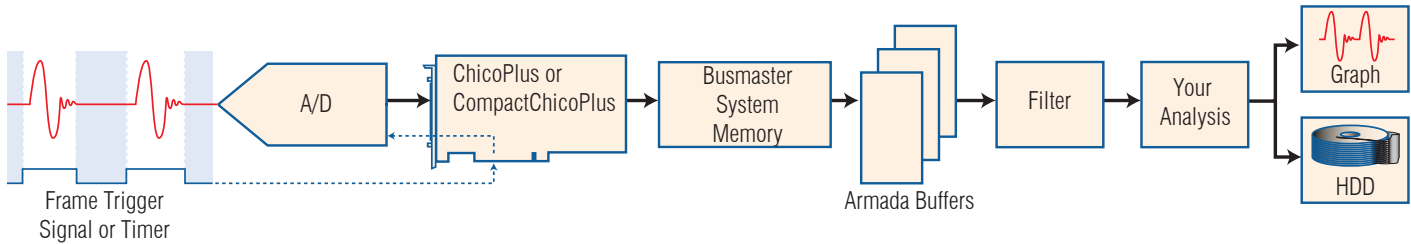

## CHANNELIZED MODE versus BLOCK MODE

Armada supports two modes of data transfer: Channelized Mode and Block Mode. In the Channelized Mode, the buffers of data received from the hardware are split in individual channels and formatted to floating-point (or even user-units) prior to viewing, processing and logging. Data rates of 20MBytes/sec can be sustained. In Block Mode, the emphasis is in preserving CPU bandwidth to achieve maximum data rates and the data is handled in its raw, captured, hardware-specific format. Data rates of 64MBytes/sec is readily achievable (Pentium III @1GHz). A post-processing step can then split channels and format the data for viewing and analysis.

### Channel Mode

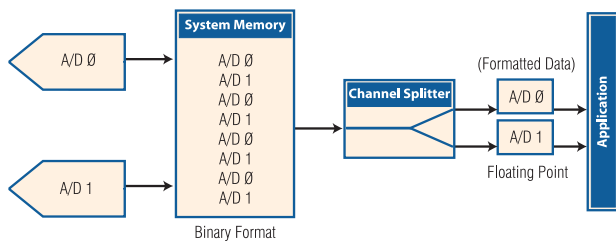

### Block Mode

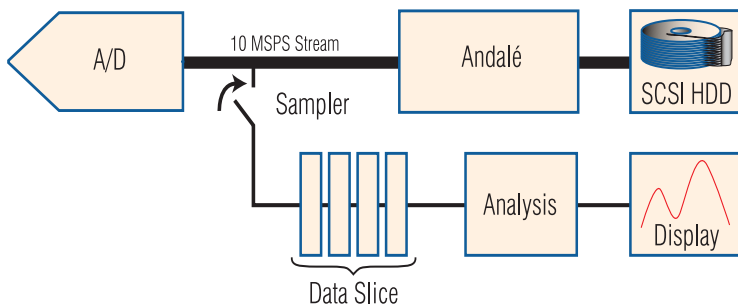
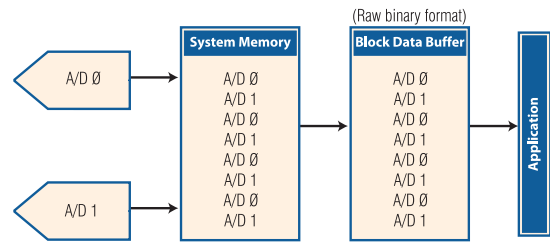

### Substream Harvesting

Data Harvesting gives lower rate data slices to minimize process burden during high rate acquisition.

Naturally, the Block Mode transfer is often used for a Snap Mode capture since they share the commonality of preserving CPU bandwidth. However, one powerful feature of Armada is that the Channelized Mode and Block Mode can be mixed and used concurrently. In this combination, the main data stream is flowing in Block Mode while a regular subset of this data stream is branched off and processed further in a Channelized Mode. The application "harvests" and process periodic "slices" of data while simultaneously flowing all data through the Block Mode interface. This is very useful for viewing and monitoring a realistic sample of data and even doing sophisticated processing. Since the amount of data processed remains small, bandwidth is preserved and the user gets the best of both worlds. This technique is much superior to a simple decimator approach that hides transients and removes high frequency content.

### Ease of Use – Real Time Acquisition Made Real Simple

The ChicoPlus board and the Armada software are installed on a PC in minutes. Sophisticated turnkey applications are included and utilize the specific features of each OMNIBUS module to offer today's most typical data acquisition schemes, "out-of-the-box". From multi-channel acquisition with graphing, disk logging and post-analysis/viewing, to externally triggered transient capture, engineers of all disciplines are finding that these executable programs have all the features to meet their immediate needs. The source code of these turnkey applications is also provided and can serve as a starting point for a custom application.

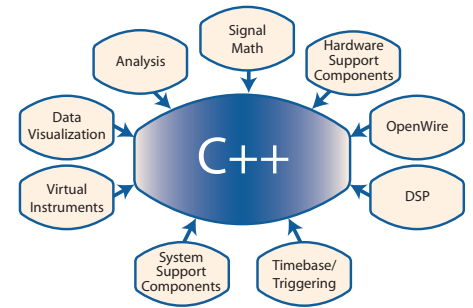

The Armada software development kit for ChicoPlus makes the board configuration and the creation of data streams extremely simple while allowing elaborate applications to be developed in a truly open environment. Unlike canned data acquisition systems that impose boundaries and demand high runtime resources, Armada lets you integrate real-time data streaming in to any Windows application while minimizing the amount of code writing, if any at all. Armada provides the best combination of performance, flexibility and ease-of-use in a totally open C++ environment. Under Borland C++ Builder, Armada provides a collection of visual VCL components. It includes graphs and virtual instruments, as well as an elaborate set of program examples utilizing all the advantages of a truly visual environment. Similarly, Microsoft Visual C++ is fully supported with the equivalent set of MFC classes and valuable example source code. VC++ users will particularly appreciate the ease of graph creation and setup with our Armada classes.

Hardware data stream components as well as the chosen analysis components, like graphs, virtual instruments, disk logging, are simply "connected" to each other via OpenWire, using a check list in Builder or using single line commands in VC++. One can construct sophisticated applications with multi-channel graphing, disk logging and signal processing like FFT or filters using Intel MMX/SIMD optimized libraries, literally in minutes. See the Armada section for more details on OpenWire.

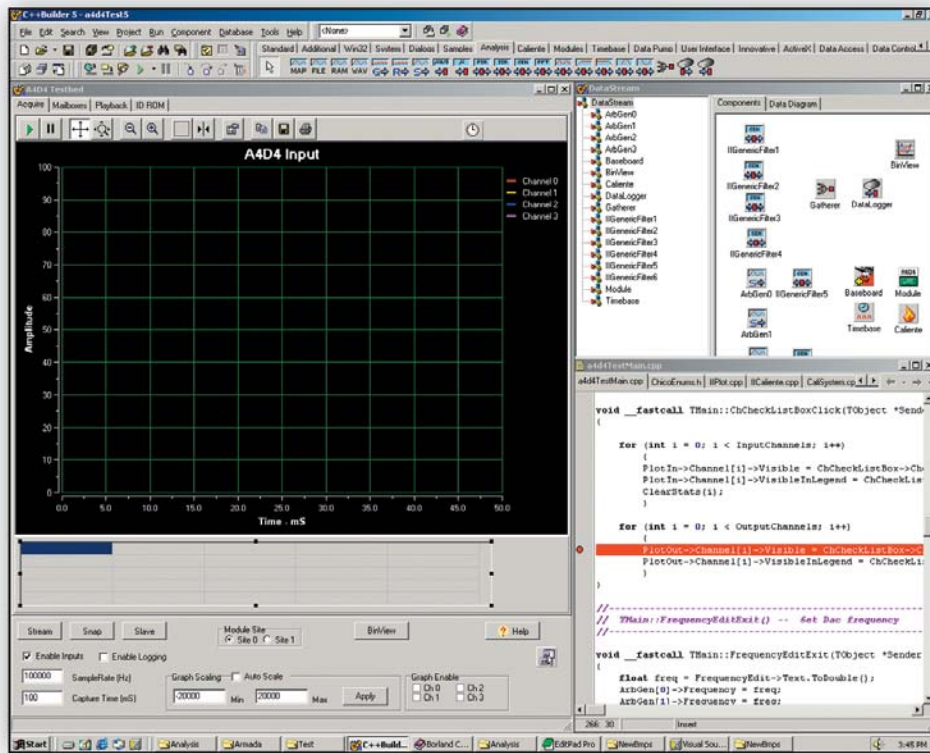

Armada running under Borland C++ Builder

Data Acquisition

## Baseboard Hardware Components

Armada's Baseboard Hardware components move data to and from the hardware and application program on demand using a set of cooperating threads and functions. The size and number of internal buffer pools is automatically adjusted to balance how often data is delivered to the system and how much data can be stored, based on the sample rates involved. Simply invoke these components to get the highest data rates from the hardware to your application without writing any code.

## Timebase Components

The timebase components control hardware timers and other pacing signal sources that are used as triggers for the acquisition of analog and digital signals within application programs. The timebases include frequency synthesizers, timers, external triggers and clock, re-triggered or framed modes, and multi-card timing synchronization signals.



## Analysis Components

The analysis components provide access to common signal processing functions and analysis functions needed in real-time data acquisition and control applications or as post-processing operations.









Most of the components are MMX and SIMD optimized code from the Intel libraries that offer the highest performance.









### Armada Baseboard Hardware Support Components

Component	Description	Application
 TIIChicoPlusBaseboard	64 MBytes/sec. data stream platform for PCI and CompactPCI.	High bandwidth, wide-channel-count, cost-sensitive data acquisition and signal generation
 TIIBlockStream	Interface to Chico non-channelized (raw), binary data streams.	Maximum rate data logging. Interface to custom Omnibus modules.
 TIICaliente	Automatic, Interrupt-driven data flow between application and multiple baseboards and Omnibus modules.	







### Armada Timebase Components

Component	Description	Application
 TIIClock	Simple periodic conversion clock source. DC-24 MHz in .01 increments.	Continuous recording or playback.
 TIIRetrigger	Framed conversion clock source. Internal or external clock is periodically gated by external framing pulse, after which fixed number of conversion clocks propagate to conversion hardware.	Non-continuous recording or playback.
 TIIClockMaster	Configures a single baseboard as master clock source for all baseboards in system. LVDS signals allow routing of DC-80MHz signals throughout system.	Multi-board synchronization.
 TIIClockSlave	Configures numerous baseboards to receive clock from TIIClockMaster in system. LVDS signals allow routing of DC-80MHz signals throughout system.	Wide-channel count systems. Multi-board synchronization.
 TIISyncMaster	Configures a single baseboard as master clock source for all baseboards in system. TTL signals allow routing of DC-2MHz signals throughout system.	Wide-channel count systems. Multi-board synchronization.
 TIISyncSlave	Configures numerous baseboards to receive clock from TIISyncMaster in system. TTL signals allow routing of DC-2MHz signals throughout system.	Wide-channel count systems. Multi-board synchronization.
 TIIEternal	Configures baseboard to receive clock from external TTL source.	Synchronization to system-supplied clock sources
 TIIModuleClock	Configures baseboard to receive clock from Omnibus-module-resident clock source	Synchronization to precision clocks on specific Omnibus modules.
 TIIMultiClock	Configures baseboard to receive clock from any timebase or clock source available on baseboard or Omnibus module. Complex component exposing all baseboard clocking features for custom applications.	Custom Omnibus modules, unanticipated clocking requirements.



### Armada DSP Components

Component	Description	Application
 TIIBandPass	Bandpass filter, variable # taps, automatic digital filter designer, 15 Mtaps/sec on Pentium III 500	Digital signal processing, control.
 TIIBandStop	Bandstop filter, variable # taps, automatic digital filter designer, 15 Mtaps/sec on Pentium III 500	Digital signal processing, control.
 TIHighPass	Highpass filter, variable # taps, automatic digital filter designer, 15 Mtaps/sec on Pentium III 500	Digital signal processing, control.
 TIILowPass	Lowpass filter, variable # taps, automatic digital filter designer, 15 Mtaps/sec on Pentium III 500	Digital signal processing, control.
 TIIFir	Generic FIR filter. Variable # taps, 15 Mtaps/sec on Pentium III 500	Digital signal processing, control.
 TIIRir	Generic IIR filter. Variable # taps, 15 Mtaps/sec on Pentium III 500	Digital signal processing, control.
 TIIFourier	Fast fourier transform, adjustable size, numerous window functions. 14000 1K-point transforms/sec on Pentium III 500	Spectral analysis.

### Armada Analysis Components

Component	Description	Application
 TIIResample	Digital resampler for sample-rate conversion.	Multi-rate signal analysis.
 TIIStats	Statistics: Min, max, mean, std dev, dynamic range, integrals	Signal analysis.
 TIAdcStats	A/D statistics: Signal-Noise, SINAD, total-harmonic distortion, harmonic analysis	Signal analysis.
 TIUser	User application data pump. Channelized data available on events.	User applications.
 TIIDataBuffer	Vector add, subtract, multiply, divide, mean, std deviation, normalization, thresholding	Fast vector arithmetic.
 TIIGather	Aggregation and collation of multi-channel data into single data block.	Data recording and transmittal.





### Armada Signal Generation Components

Component	Description	Application
 TIIGaussGen	User-adjustable gaussian noise source. Pentium-optimized assembler.	Frequency response testing vibration.
 TIIRandomGen	User adjustable random noise source. Pentium-optimized assembler.	Frequency response testing vibration.
 TIISigGen	User-adjustable arbitrary signal source. Sin, Cos, Triangle, Square waves. Pentium-optimized assembler.	Frequency response testing vibration.























## Signal Generation

ChicoPlus can be used to generate and play specific waveforms, typical noise patterns or user programmed arbitrary signal shapes.



**Armada Data Visualization Components**

Component	Description	Application
 TIIRport	Simplifies access to TRichEdit control. Methods for font control, dynamic content management.	Runtime log files and report generation.
 TIIBoolDisplay	Bi-modal display of boolean information as pairs of graphical images.	User interfaces.
 TIIPlot	Real-time, multi-channel, multi-axis, X-Y data plotting	Data visualization and analysis
 TIIBinView	Remote control interface for BinView application.	Automated time and frequency-domain data display within user applications.

**Instrumentation Components**

Component	Description	Component	Description
 TIIGradient	Gradient proportioned to data	 TISevenSegmentAnalog	Seven-segment LED
 TILedBar	Linear LED array	 TISevenSegmentBinary	Seven-segment LED
 TILinearGauge	Linear numeric gauge	 TISevenSegmentHex	Seven-segment LED
 TIAngularGauge	Circular numeric gauge	 TISevenSegmentInteger	Seven-segment LED
 TILedSpiral	Circular LED array	 TISevenSegmentCharacter	Seven-segment LED
 TIThermometer	Familiar thermometer device	 TISevenSegmentClock	Seven-segment LED
 TIAnalogDisplay	Analog input voltage display	 TIKnob	Rotary knob
 TIAnalogOutput	Analog output voltage display	 TISlider	Linear potentiometer
 TIOdometer	Rolling odometer display	 TISwitchLed	Push toggle switch
 TILedRectangle	Rectangular LED	 TISwitchToggle	Slide toggle switch
 TILedRound	Circular LED	 TISwitchRotary	Rotary toggle switch
		 TISwitchSlider	Linear toggle switch

**Armada Record/Playback Components**

Component	Description	Application
 Andalé	High speed data logging/playback to dedicated SCSI Drive. (optional)	Data logging/playback
 TIIDataLogger	Records raw data received from any input device to Windows local or network disks.	High bandwidth data recording. Block-mode signal recorders.
 TIIDataPlayer	Retrieves raw data previously stored to Windows local or network disk for real-time output.	High bandwidth data playback. Block-mode signal players.

**Data Visualization**

Armada includes powerful data visualization tools that make user interface creation fast and simple.

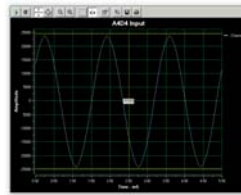

**Graphing Component - Real-time display**

The graphing component gives both Borland and Visual C++ users the ability to quickly develop data graphs. Multiple channels may be simultaneously displayed on a single graph for applications like strip chart recorders and oscilloscopes. Full control of the graph type, scaling and point marking make it easy to develop sophisticated displays. Interactive features allow the user to measure data during acquisition.

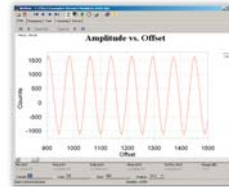

**BinView - Post-processing and analysis**

BinView is a powerful data graphing and analysis tool that you can directly interface to your application as a post-processing analysis tool. This component gives you full control of BinView which allows you to view all types of data sets of virtually unlimited size. Built-in analysis functions allow you to look at results like time domain statistics as well as frequency domain results like signal to noise ratio, THD and SINAD. Scrolling and data search features allow you to quickly scan through large data sets.



**Virtual Instrumentation**

Armada ships with a superb group of graphical virtual instrumentation components. The Instrument Pack is a collection of 27 advanced instrumentation components for automation software development with elegant user interfaces.

**Recording and Playback of Data**

**Data Logging and Playback using Windows Disks**

Armada provides built-in support and extensive examples for data logging and playback applications. You can record data to disk, playback from disk at rates up to 2-4 Mbytes/s for system disks with the components supplied with Armada. You can also record to network drives for system integration.

**Andalé - High Speed Data Logging and Playback**

For higher rates of 20 Mbytes/s to a dedicated SCSI hard drive, a collection of components called Andalé is available. Andalé allows Armada applications to directly control a high speed dedicated SCSI drive through a unique architecture that allows the Armada application to tightly couple the SCSI controller with the data acquisition system using shared memory.

## Deploying Applications using Armada

### Deployment Methods

Applications developed using the Armada Toolset may be deployed as executables, DLLs, ActiveX or VCL components. This gives you the flexibility to use these applications stand-alone or as a part of a larger application.

### No Royalties or License fees

There are no royalty or licensing fees required to deploy the finished applications.

### Help System

Armada comes with a complete help system that is designed to introduce you to the Armada software, demonstrate development techniques and provide on-line active help during software development.



### Tutorials

Learn from the ground up how to use ChicoPlus and Armada for common data acquisition and analysis applications



### Example Programs with Source Code

Refer to example programs to see how ChicoPlus and Armada can be used. Each example shows how real hardware is configured and used for applications such as data logging, transient capture and signal processing.



### On-line help

Use the extensive on-line help during application development as a reference for details like component properties, class definitions, methods, events and more.



### Manuals

The ChicoPlus manual covers a variety of topics from orientation and tutorials to specifics on hardware use and features that complement the on-line help.



### Telephone/e-mail Support

Innovative Integration has technical support ready to assist you and put you in touch with the experts.



### Training

Training sessions are available to get you off to a fast start and speed up your application development. Sessions take place at our office. Call for pricing information.

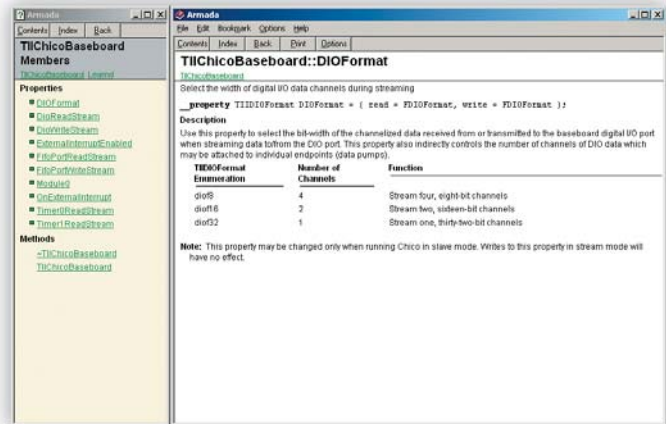
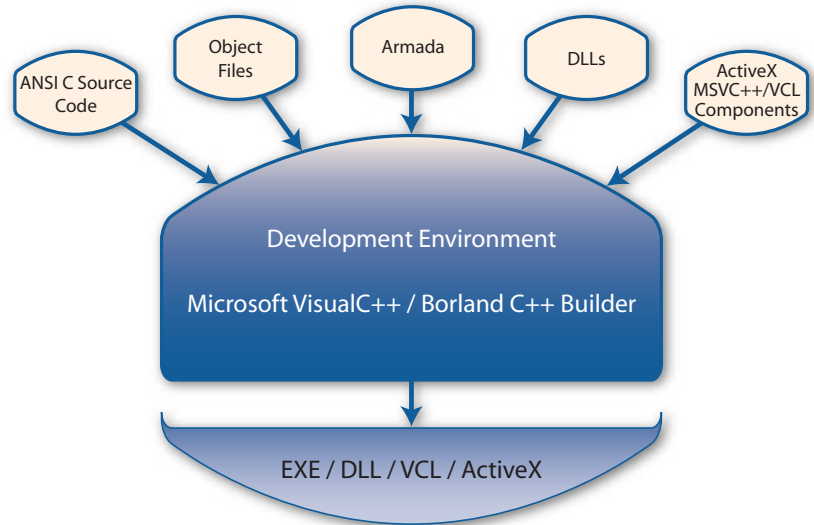

Armada on-line help screen

## Data Streaming

Up to 64 Mbytes/sec continuous  
 Event driven transfers using timers, external triggers or Host CPU events  
 Any ChicoPlus peripheral or module may be part of the data stream  
 Four streams - high-speed in/out and low-speed in/out

## Digital I/O

32-bit, Current drive +32/-64 mA  
 Directly drives diodes, opto-couplers and Opto-22 isolation modules  
 Software configurable as bytes for input or output  
 Inputs are latched by internal events or external digital trigger  
 Max Speed: 10 MHz

## FIFOPort (FIFOCable Required)

Direct connection to Innovative Integration FIFOPort compatible cards over private 16-bit bus allows high-speed, bidirectional transfers at up to 64 Mbytes/sec  
 Buffered FIFO input for data stream

## Timers/Counters

Two 24-bit timer/counters  
 Cascadable for 48-bit counter  
 Software-selectable timer sources: 80 MHz clock module, programmable clock (DDS), external clock input (80 MHz max.)  
 Timer input sources may be hardware gated

## Clock Generation

(1) Direct Digital Synthesizer (DDS)  
 0-25 MHz range in 0.02 Hz steps

## Multiple Card Synchronization

Synchronize multiple ChicoPlus cards with SyncLink to a common trigger or timebase for system expansion  
 Software selection for master/slave card function (one card per system is master and sources all sync signals)  
 Two CIKLink signals (In & Out) to synchronize multiple ChicoPlus cards to a high speed clock (2) expansion sites  
 Expansion using OMNIBUS modules for analog and digital I/O

## OMNIBUS I/O Sites



Up to 16 MHz accesses on 32-bit bus (modules may require wait states)

## OMNIBUS Bandwidth

Bursts at 132 Mbyte/sec  
 Master/slave interface  
 Bus mastering controlled by ChicoPlus  
 Automatically streams data to/from ChicoPlus as required by data process

## PCI Bus

Plug-n-Play compatible  
 Consumes 2 MBytes memory space  
 All features accessible in slave mode for easy configuration and control  
 Status register for PCI FIFO control, interrupt acknowledgment and card control  
 Software selectable interrupt sources

## Physical Description

PCI half-card (4.4 in x 7.9 in)

## Power Requirements

+5V@ 220 mA, +12V@ 25mA, -12V@ 0 mA, plus module consumption

## Connectors

100 Pin MDR for OMNIBUS I/O access (Mating Part # 3M 101A0-6000EC and Shell Part # 3M 103A0-12R1-00)  
 54 Pin male header for FIFOPort  
 40 Pin IDC for digital I/O

## Development Software

### PC

Armada - Component Library & DLL  
 Borland C++ Builder Visual Environment  
 Microsoft Visual C++

### Host PC

Intel processor recommended for max speed in applications using Channelized Mode and Analysis Components, which utilize MMX technology

## Software Selection Guide for ChicoPlus

Software Package	Description	Usage/Requirements	Page	Recommendations
<b>Armada</b>	Host side development package using a revolutionary integrated development environment (IDE). Allows user to build/debug sophisticated data acq apps fully using MS Windows graphical environment quickly with Innovative Integration's Visual Component Libraries (VCL) of MFC Classes.	Requires Borland C++ Builder* or Microsoft Visual C++.	103	Recommended for inexperienced and seasoned C/C++ programmers. Offers easiest interface while providing the most flexibility and performance. Ties into a plethora of 3rd party components.
<b>Caliente DLL</b>	Dynamic link library (DLL) for the ChicoPlus.	Requires ANSI-compliant C/C++ compiler. Windows2000/XP compatible.		Recommended for experienced C/C++ programmers. Offers access to board level functions through DLL function calls. May be used without Armada although not recommended.
<b>DASYLab Driver</b>	DASYLab driver with ChicoPlus examples. Uses a fully graphical development interface to configure hardware and define acquisition mode. Not included in DevPack. Available for download from website.	Requires DASYLab*		Recommended for simple to intermediate applications. Does not support full bandwidth or all triggering modes available on ChicoPlus. Call for details.

\*Contact Innovative Integration for current release version.